

The Oculus M series multibeam sonars are a new generation of compact imaging sonar, designed for use across a wide variety of underwater applications.

Their small form factor makes them ideally suited for deployment onto micro sized platforms, while their rugged construction also makes them an excellent choice for larger work-class vehicles and subsea infrastructure.



Oculus M750d
125mm x 122mm x 62mm
360g in water, 980g in air

M370s

With a 200m range capability, this sonar is a cost effective alternative to traditional mechanically scanned sonars, typically being used for long range navigation and situational awareness.

M750d

A general purpose **dual-frequency** 750kHz/1.2MHz sonar offering up to 120 metre range capability for navigation and high resolution imagery for near field target identification.

M1200d

Offering the highest resolution in the M series range, the **dual frequency** 1.2MHz/2MHz M1200d may be used for specialised inspection tasks where image quality is critical with ranges up to 40m.

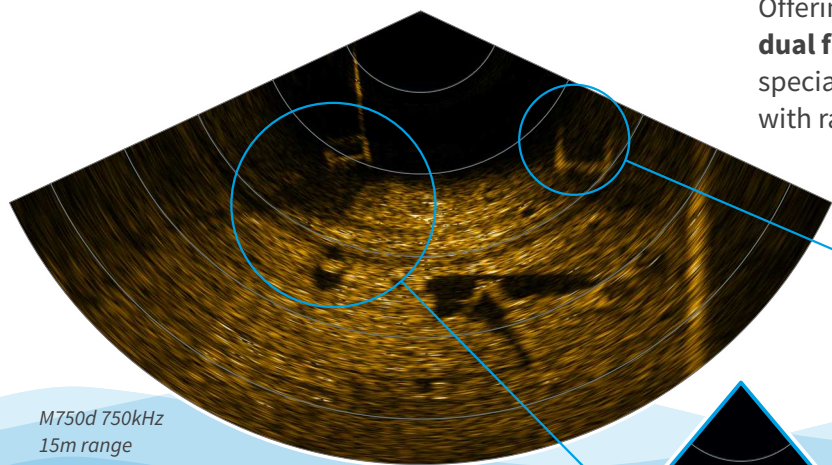

M750d 750kHz
15m range



M750d 1.2MHz
Car Tyre & IBC

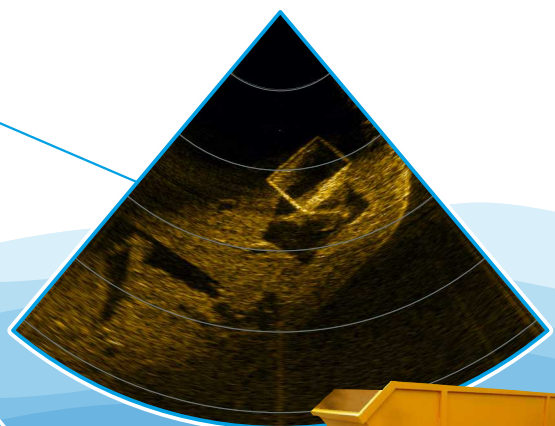

M750d 1.2MHz
Skip/Dumpster



M1200d 2.1MHz
5m range
School of Fish

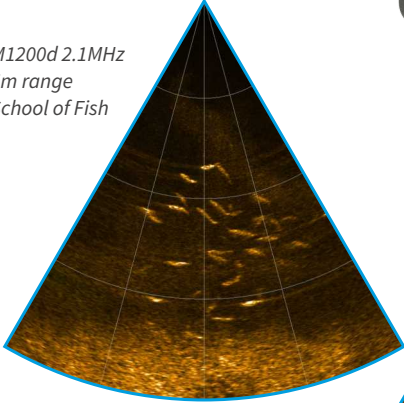

M1200d 2.1MHz
5m range
Scuba Diver

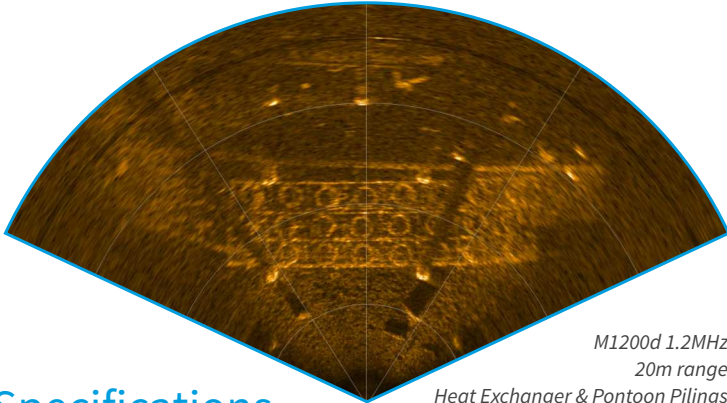
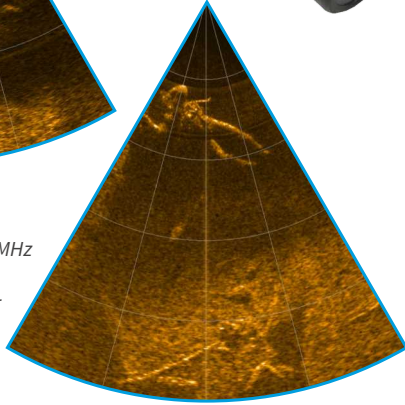

M1200d 1.2MHz
20m range
Heat Exchanger & Pontoon Pilings

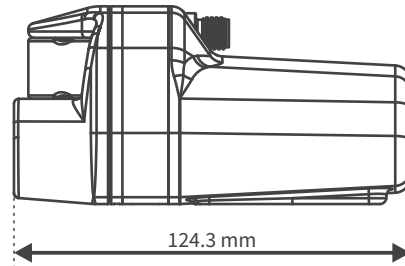
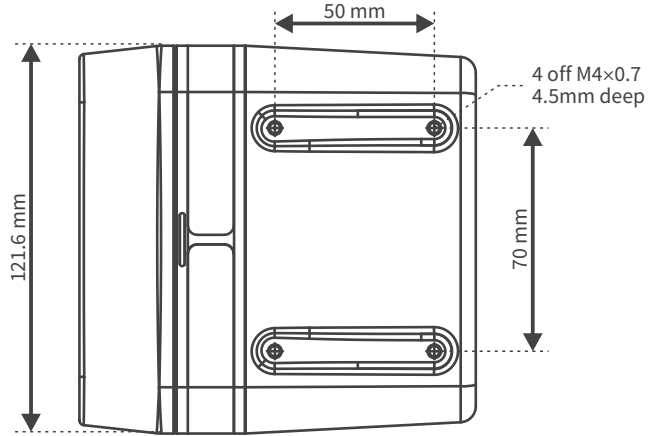
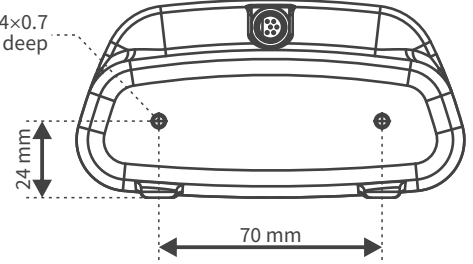
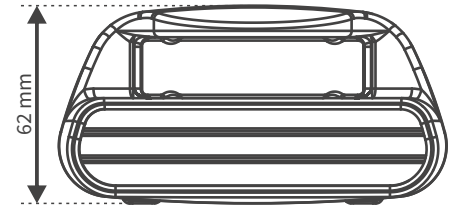

Specifications

Mechanical

Dimensions	125mm Long × 122mm Wide × 62mm High
Construction	Anodised Aluminium
Weight	980g (air), 360g (water) Neutral buoyancy pack available
Depth Rating	300m
Temperature Range	-5°C to +35°C (operating) -20°C to +50°C (storage)

Electrical

Connector	Impulse IE55 Series, 6-way
Communications	4-wire 100-BaseT Ethernet, 2-wire DSL extender module (Trigger in/out and RS232 aux options ♦)
Supply Voltage	18V to 32V isolated DC (12V non-isolated option ♦)
Power Consumption	10W to 35W (model and range dependent ★)
Integrated Sensors	Water pressure and temperature (for Velocity-of-Sound calculation)

Performance

	M370s BP01041	M750d BP01032	M1200d BP01042
Operating Frequency	375kHz	750kHz / 1.2MHz	1.2MHz / 2.1MHz
Range (max)	200m	120m / 40m	30m / 10m
Range (min)	0.2m	0.1m	0.1m
Range Resolution ★	8mm	4mm / 2.5mm	2.5mm / 2.5mm
Update Rate (max) ★	40Hz	40Hz	40Hz
Horizontal Aperture	130°	130° / 70°	130° / 60°
Vertical Aperture	20°	20° / 12°	20° / 12°
Number of Beams (max)	256	512	512
Angular Resolution	2°	1° / 0.6°	0.6° / 0.4°
Beam Separation	0.5°	0.25° / 0.16°	0.25° / 0.16°

★ indicates parameter is dependent on range
♦ consult factory for availability and further details